

CHIP TRIPLETT HICKORY ROAD MADISON, MS,	DESIGN PLANS LARGE LAKE DRAINAGE	DATE 6-12-13 SCALE _____ SHEET 1 OF 2	JOB NO. AQ 1314	AQUA ENGINEERING SERVICES 103C PLANTATION COVE MADISON, MS.
---	--	---	--------------------	---

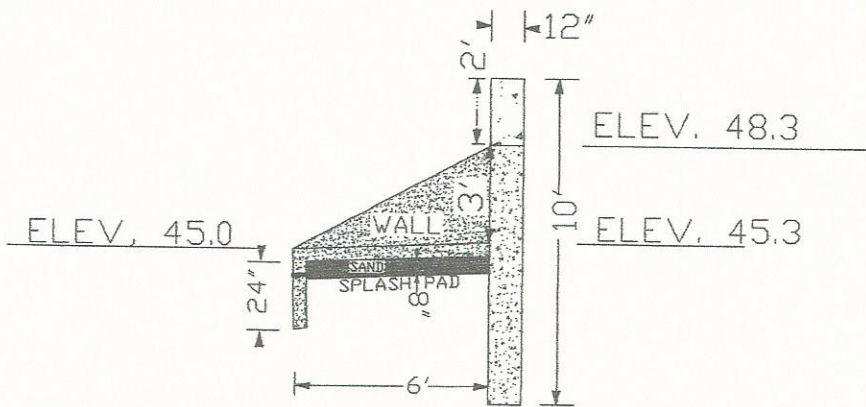

PLAN VIEW

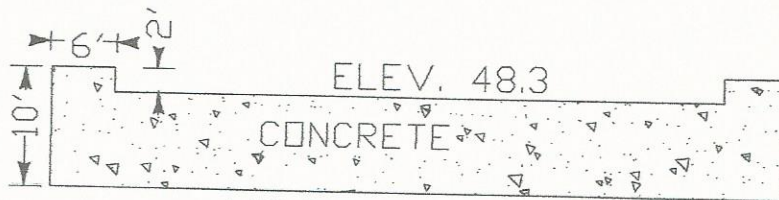
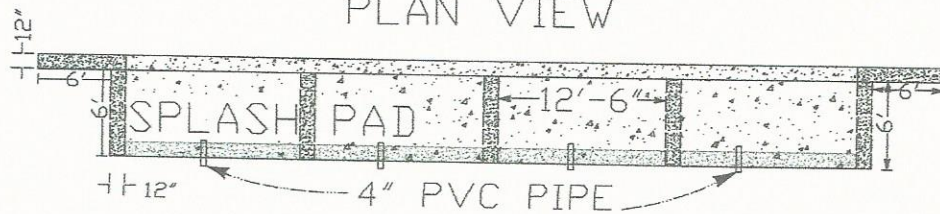

WEIR WALL FRONT
LOOKING D/S

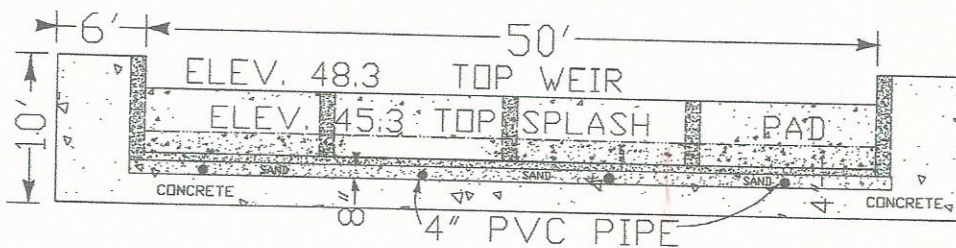

LOOKING U/S 62'

CHIP TRIPLETT HICKORY ROAD MADISON, MS,	DESIGN PLANS LARGE LAKE DRAINAGE	DATE 6-12-13 SCALE _____ SHEET 2 OF 2	JOB NO. AQ 1314	AQUA ENGINEERING SERVICES 103C PLANTATION COVE MADISON, MS.
---	--	---	--------------------	---

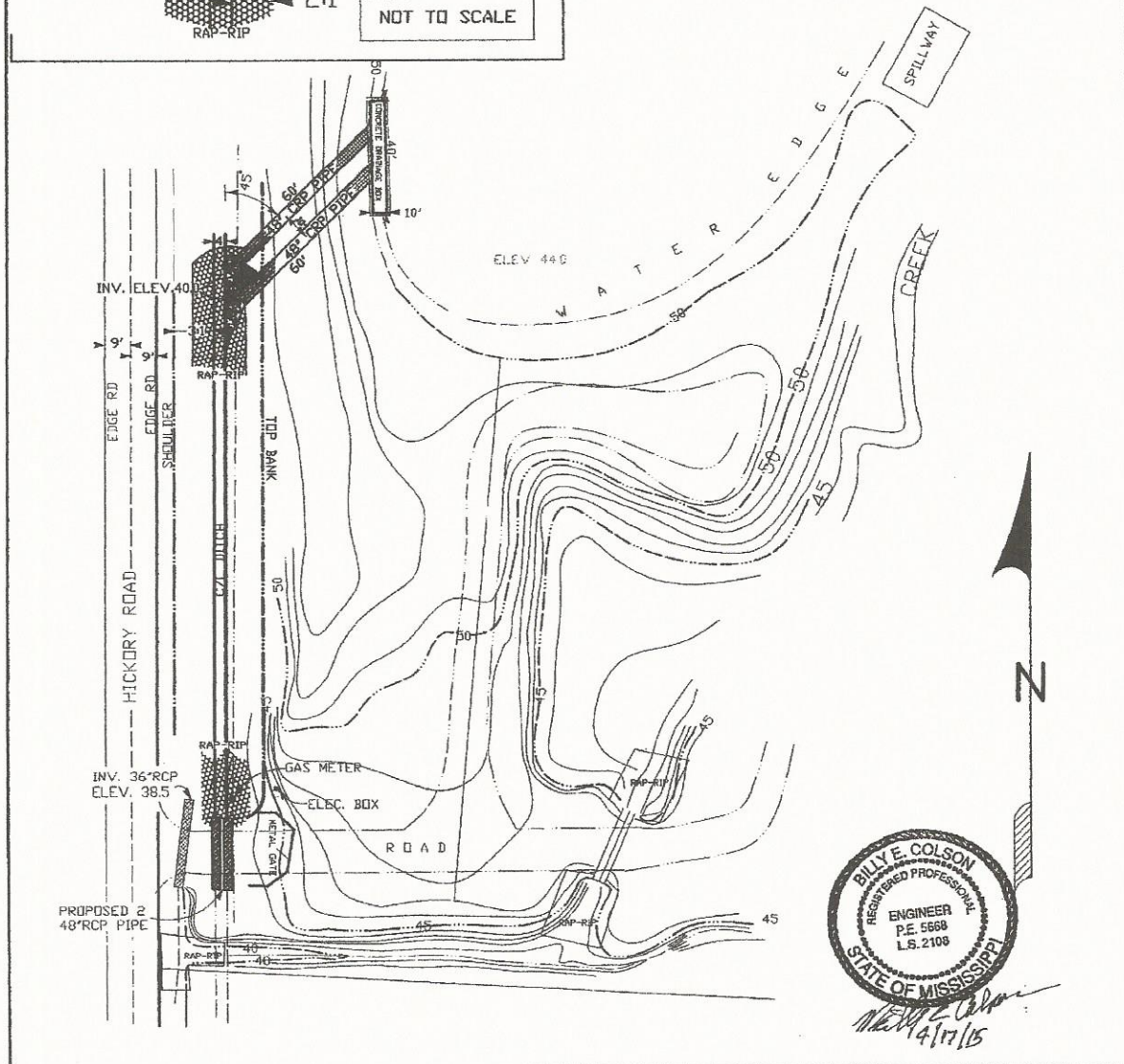
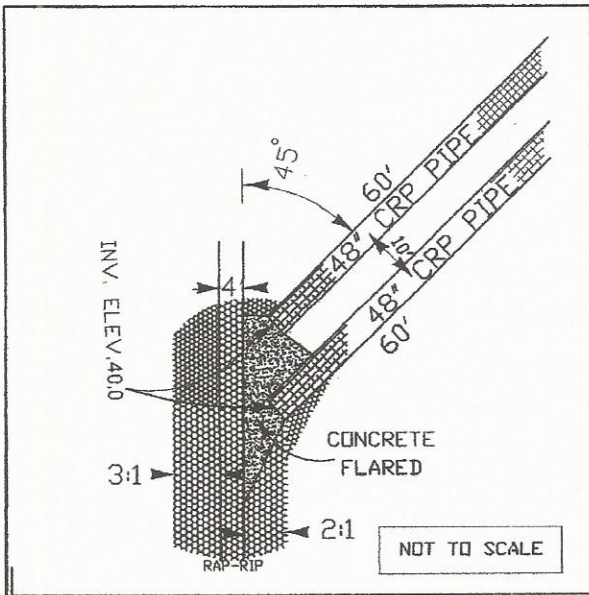

Billy E. Colson
4/17/15

TRIPLETT DITCH HICKORY ROAD MADISON CO. MS.	REVISED PLANS FOR DITCH LOCATION	SHEET 1 OF 2 DATE 4-45-15 SCALE 1" = 40'	JOB NO AQ1434	AQUA ENGINEERING SERVICES 103C PLANTATION COVE MADISON, MS.
---	-------------------------------------	--	------------------	---

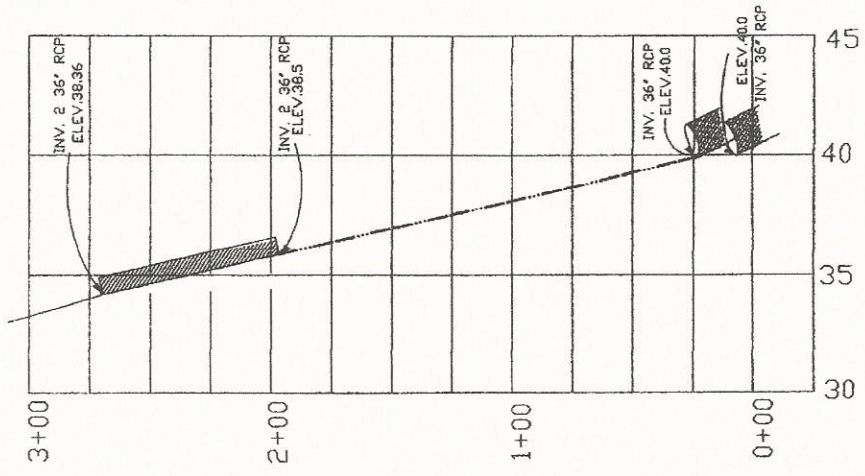

PROFILE C/L DITCH

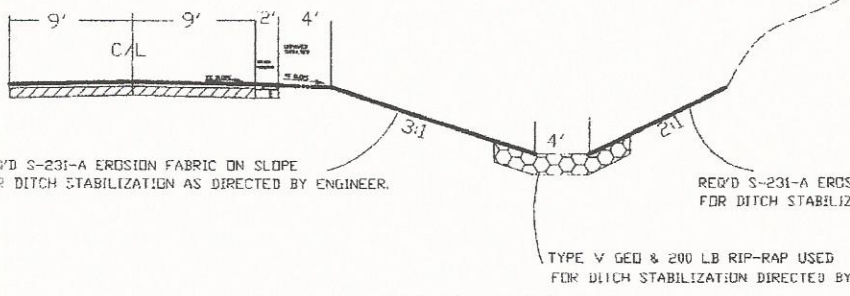

NOT TO SCALE

GENERAL NOTE:

CONTRACTOR SHALL VERIFY LOCATIONS FOR ALL UTILITIES BEFORE ANY CONSTRUCTION WORK OR GROUND DISTURBANCE. CONTRACTOR SHALL ASSUME ALL RESPONSIBILITY AND LIABILITY FOR ANY DAMAGE TO UTILITIES OR HARM TO PERSONS OR PROPERTY RESULTING FROM CONSTRUCTION WORK IN THE VICINITY OF UTILITIES OR OTHERWISE.



Billy Colson
4/17/15

TRIPLETT DITCH HICKORY ROAD MADISON CO. MS.	REVISED PLANS FOR DITCH LOCATION	SHEET 2 OF 2 DATE 4-15-15 SCALE 1" = 40'	JOB NO AQ1434	AQUA ENGINEERING SERVICES 103C PLANTATION COVE MADISON, MS.
---	-------------------------------------	--	------------------	---